

FBR

BURNERS MADE IN ITALY

BURNER

FNDP 750/M - FNDP 1000/M - FNDP 1300/M EL

FNDP 1500/M - FNDP 1800/M EL

FNDP 750-1000-1300-1500-1800/M-EL

ELECTRONIC MODULATION

Heavy oil burners at 2 stages progressive (hi-low flame) or modulating (PID fully modulating) if equipped with modulation kit and probe.

Equipped with Lamtec ETAMATIC OEM electronic camme. Fan at high pressurization, high efficiency combustion head with adjustment and high flame stability, pump, multistage preheating tank and degaser skid. Suitable for heavy oil up to 50°E to 50°C and for BTZ heavy oil.

Rational disposal of components with easy accessibility for calibration and maintenance operations.

The adoption of strong metal components makes the burner durable also in heavy duty conditions.

Burners are supplied with nozzle, gasket for installation on boiler, heaters of the pumping unit are adjusted with electronic thermostat for high precision control of the heating temperature.

Optional accessories:

- Frequency control (inverter)
- Ventilation system on control panel
- Can/bus or Profibus interface
- PC interface
- Programming unit (handset)
- Modulation kit
- Probe (temperature or pressure)



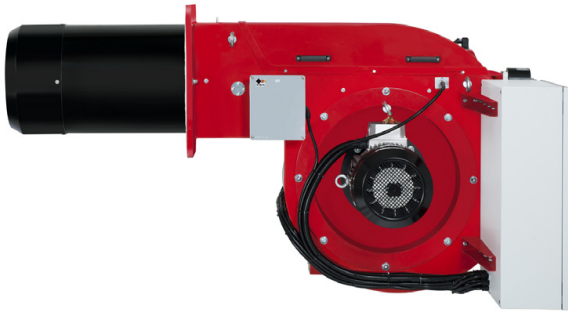

Pump skid



Degaser

Motor 1400 rpm

Multistage pre-heating tank with specific flanged heaters

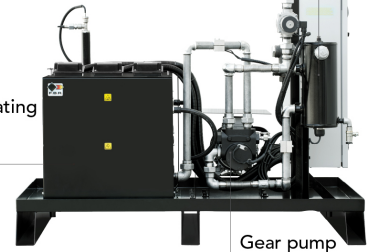

Gear pump

ELECTRONIC MODULATION

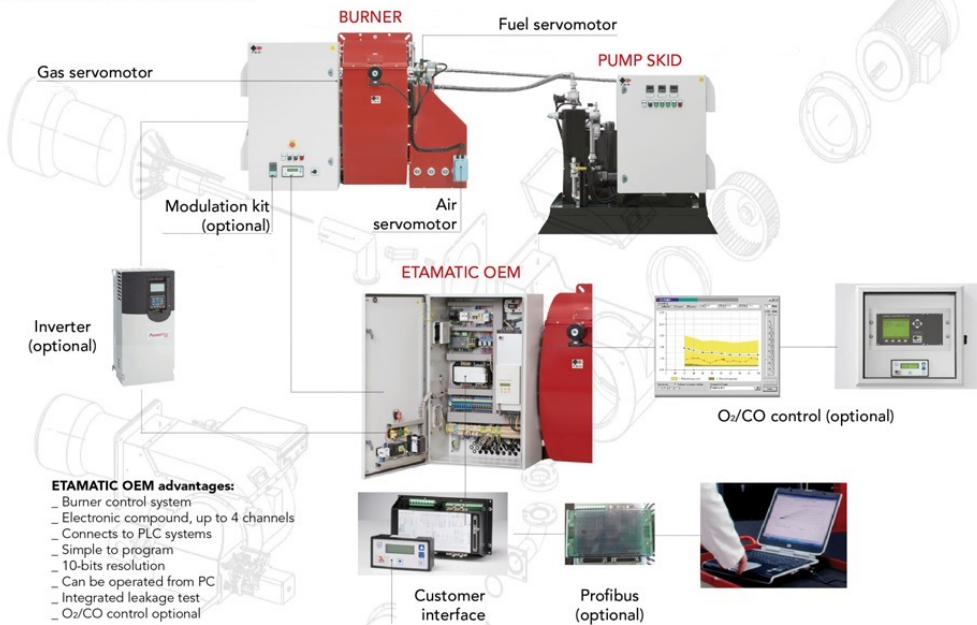

Sensors and systems for combustion technology

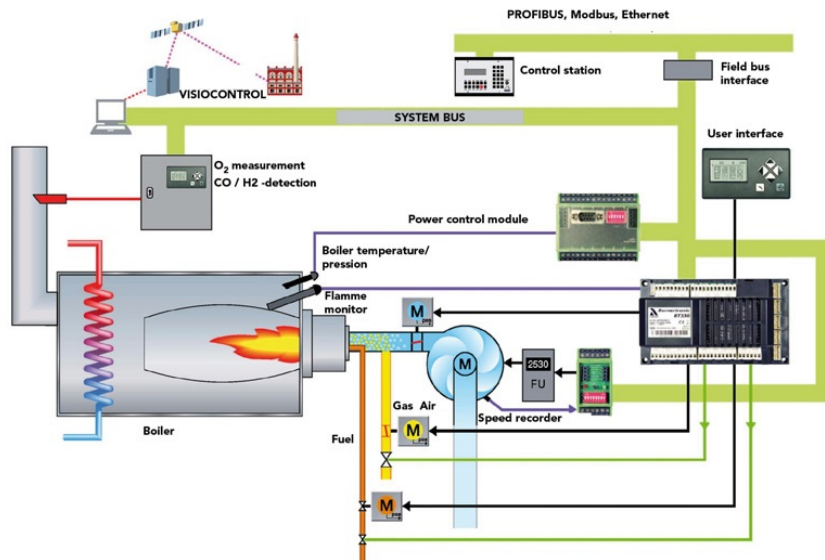

TECHNICAL DATA

MODEL		FNDP 750/M-EL	FNDP 1000/M-EL	FNDP 1300/M-EL
Thermal power min 1°st./min 2°st.-max 2°st. *	[Mcal/h]	1200/3400-7500	1200/3400-10000	1700/3600-11500
Thermal power min 1°st./min 2°st.-max 2°st. *	[kW]	1395/3953-8721	1395/3953-11628	1977/4186-13372
HEAVY-OIL flow min 1°st./min 2°st.-max 2°st. *	[kg/h]	122-347-765	122/347-1020	173/367-1173
Fuel		Heavy-oil 5° -50°E at 50°C		
Intermittent working operation (min, 1 stop every 24 hours) two stages progressive or modulating				
Enviromental conditions operation/storage		-15...+40°C / -20...+70°C ,relative humidity max. 80%		
Max temperature combustion air	[°C]	60	60	60
Nominal electric power	[kW]	25.5	34.5	41.5
Fan motor	[kW]	22	30	37
Pump motor	[kW]	3	4	4
Power supply		3~400V-1/N~230V-50Hz	3~400V-1/N~230V-50Hz	3~400V-1/N~230V-50Hz
Degree of electric protection		IP44	IP44	IP44
Noisiness**max	[dB(A)]	89	91	93

* Reference conditions: Environment temperature 20°C - Barometric pressure 1013 mbars - Altitude 0 metre (sea level).

** Measured sonorous pressure in the laboratory combustion, with functional burner on beta boiler to 1 metre of distance (UNI EN ISO 3746 law).

FIRING RATES

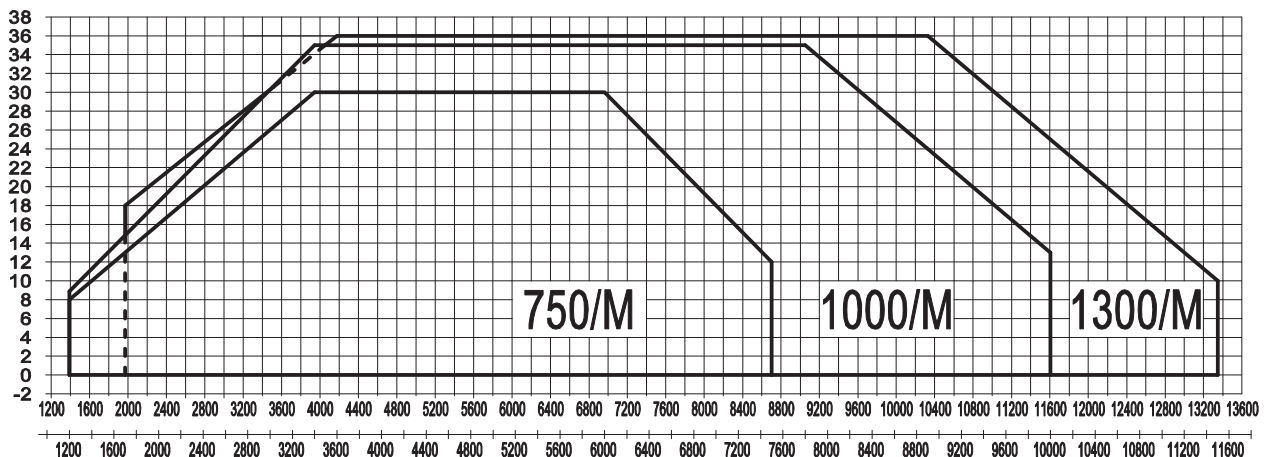

Fig. 2 X = Thermal power (kW - Mcal/h) Y = Pression in the combustion chamber (mbar)

The firing rates has been obtained based on test boilers in accordance with EN267 standards and are indicative of matching the burner to the boiler. For the correct operation of the burner, combustion chamber dimensions must be in accordance with current regulation. In case of non-compliance, contact the manufacturer.



TECHNICAL DATA

MODEL		FNDP 1500/M-EL	FNDP 1800/M-EL
Thermal power min 1°st./min 2°st.-max 2°st. *	[Mcal/h]	1700/3600-13000	2000/5000-15000
Thermal power min 1°st./min 2°st.-max 2°st. *	[kW]	1977/4186-15116	2325/5815-17442
HEAVY-OIL flow min 1°st./min 2°st.-max 2°st. *	[kg/h]	173/367-1326	204-510-1531
Fuel		Heavy-oil 5° -50°E at 50°C	
Intermittent working operation (min, 1 stop every 24 hours) two stages progressive or modulating			
Enviromental conditions operation/storage		-15...+40°C / -20...+70°C ,relative humidity max. 80%	
Max temperature combustion air	[°C]	60	60
Nominal electric power	[kW]	49.5	61
Fan motor	[kW]	45	55
Pump motor	[kW]	4	5.5
Power supply		3~400V-1/N~230V-50Hz	3~400V-1/N~230V-50Hz
Degree of electric protection		IP44	IP44
Noisiness**max	[dB(A)]	97	101

* Reference conditions: Environment temperature 20°C - Barometric pressure 1013 mbars - Altitude 0 metre (sea level).

** Measured sonorous pressure in the laboratory combustion, with functional burner on beta boiler to 1 metre of distance (UNI EN ISO 3746 law).

FIRING RATES

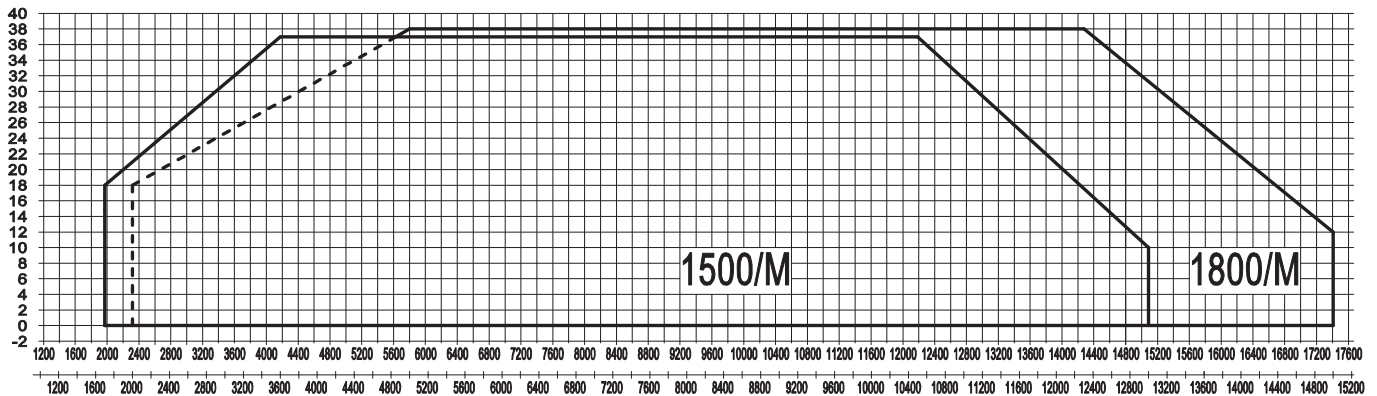
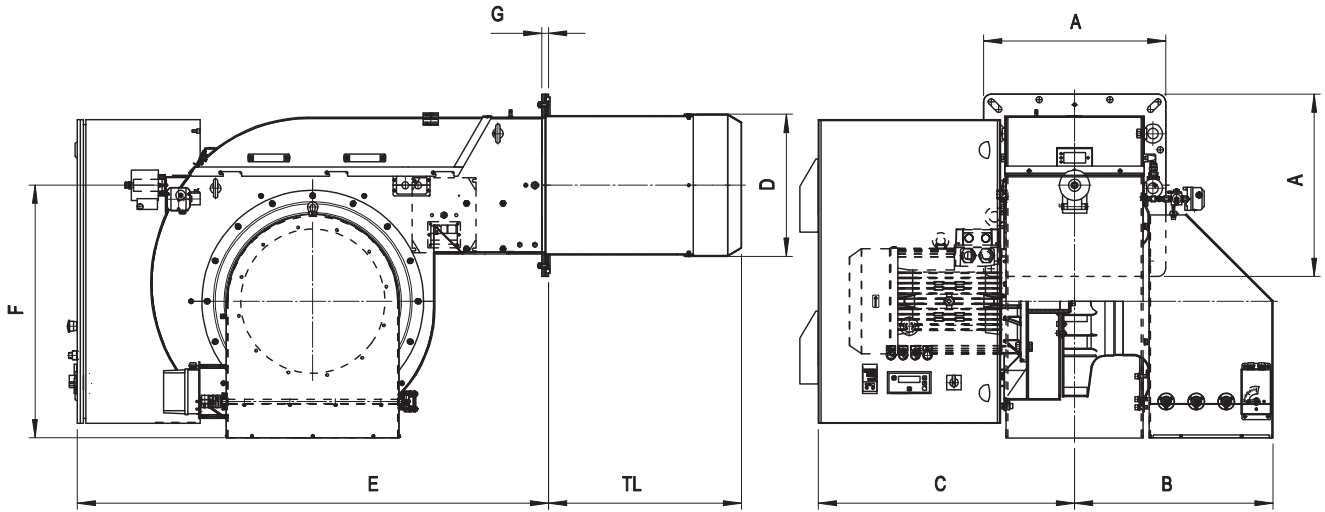

Fig. 3 X = Thermal power (kW - Mcal/h) Y = Pression in the combustion chamber (mbar)

The firing rates has been obtained based on test boilers in accordance with EN267 standards and are indicative of matching the burner to the boiler. For the correct operation of the burner, combustion chamber dimensions must be in accordance with current regulation. In case of non-compliance, contact the manufacturer.

DIMENSIONS [mm]



MODEL	A	B	C	D	E	F	G	TL
FNDP 750/M-EL	600	832	1508	448	845	654	22	685
FNDP 1000/M-EL	600	832	1508	468	845	654	22	685
FNDP 1300/M-EL	600	832	1508	499	845	634	22	655
FNDP 1500/M-EL	600	832	1508	499	845	634	22	655
FNDP 1800/M-EL	700	884	1660	540	875	680	22	685

BOILER PLATE

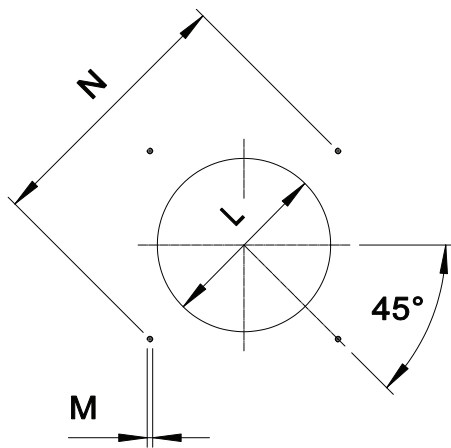

The dimensions of the boiler plate (threaded holes or studs) must be as indicated in the drawing.

MODEL		M	N min	N*	N Max	Lmin	Lmax
FNDP 750/M-EL	mm	M16	707	778	778	460	540
FNDP 1000/M-EL	mm	M16	707	778	778	480	540
FNDP 1300/M-EL	mm	M16	707	778	778	510	540
FNDP 1500/M-EL	mm	M16	707	778	778	510	540
FNDP 1800/M-EL	mm	M18	806	890	890	550	630

* Suggested dimension

PUMP SKID: DIMENSIONS (mm)

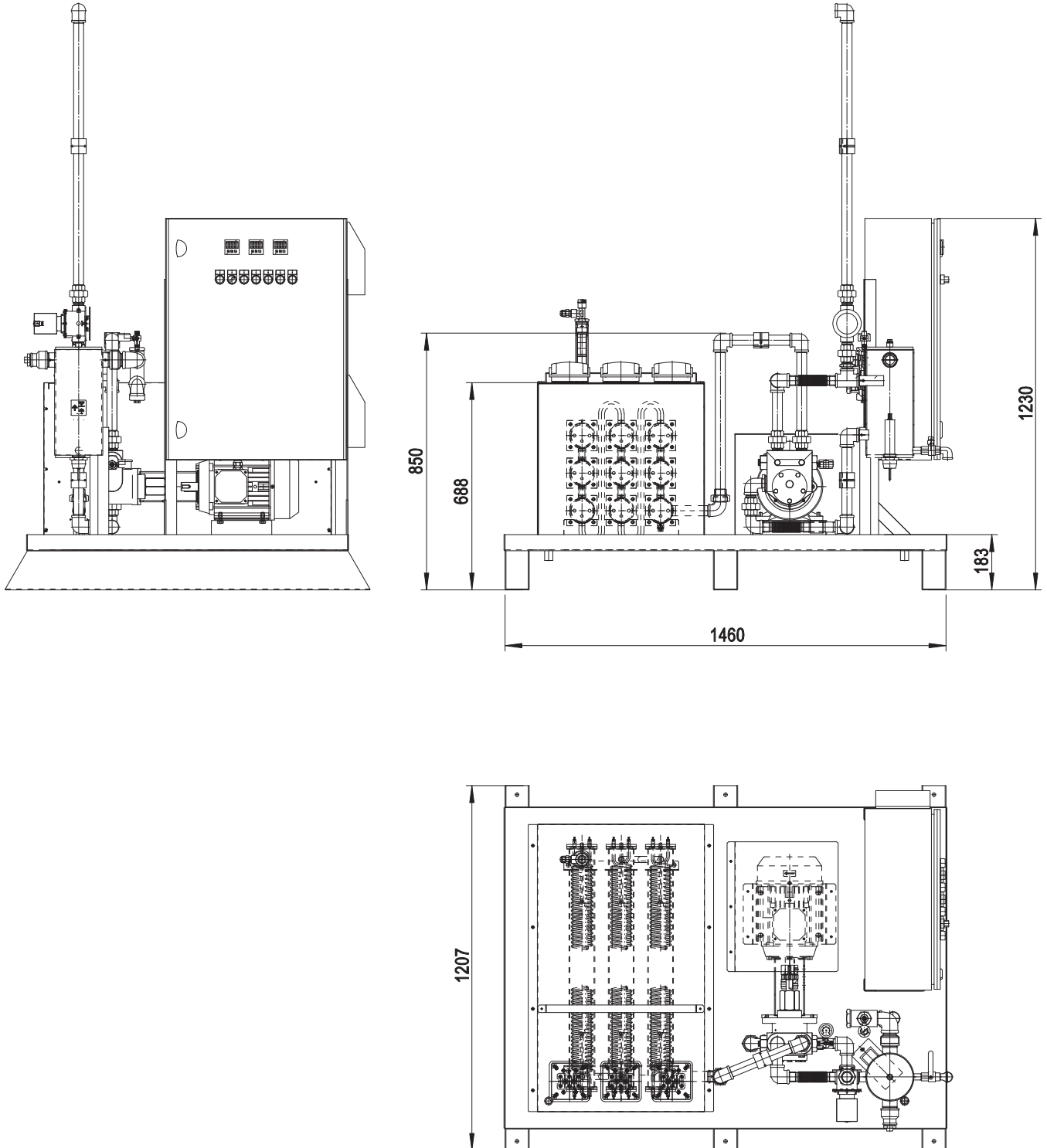



PRODUCT SPECIFICATION

SHORT DESCRIPTION

Heavy oil burners at 2 stages progressive (hi-low flame) or PID fully modulating if equipped with modulation kit and probe. Available versions for heavy oil up to 50°E to 50°C and ecological heavy oil BTZ (low sulfur oil).

DETAILED SPECIFICATION

Heavy oil burners from 5 to 50°E at 50°C, 2 stages progressive (hi-low flame), with possibility of modulating working (PID fully modulating with optional modulation kit and probe). The burner is composed by:

- Frame made of steel completed by specific boiler plate;
- Centrifugal fan at high pressurization with reverse curved blades at low noisiness;
- Combustion head with adjustment at high performance and elevated flame stability equipped with inox steel blast tube and steel flame disc;
- Easy extraction of combustion head without get off the burners by bolier;
- Combustible-air adjustment for optimal combustion value;
- Flange and insulating gasket for fixing at boiler/furnace;
- Minimum and maximum temperature thermostat;
- Electronic control system for controlling and command the burner;
- UV Photocell for flame detection;
- Three-phase power supply;
- Fan motor start-up made by softstart system (on model FNDP 1500/M-EL and FNDP 1800/M-EL);
- IP44 electric protection level;
- Safety air pressure switch to stop the burner in case of failed or anomalous fan operation;
- Servomotor for air shutter;
- Mobile shutter with total closure when idle for minimize the energetic losses related at boiler cooling;
- Servomotor for heavy oil adjust;
- Heavy oil gear pump operated by specific electric motor;
- Multistage pre-heating tank with specific flanged heaters at low density (anticracking);
- Pressure manometer on inlet pump;
- Thermometer inside pre-heating tank for temperature heavy-oil;
- Nozzle assembly with magnet to control inlet/return needle nozzle;
- Double filter between pump and nozzle;
- Set up for the additional specific kit that transforms burner operation as modulating i.e.the modulating kit allows to supply any power between the minimum and maximum value based on instantaneous loading request.

CONFORMING TO:

- CE rules;
- 2004/108/CE Directive E.M.C.;
- 2006/95/CE Directive L.V.;
- 2006/42/CE Directive M.D.;
- 97/23/CE Directive P.E.D.;
- Reference rules: EN267 (liquid fuel) - EN746-2 (industrial thermoprocessing equipment)

STANDARD EQUIPMENT

- Flexible pipes for connection
- Line filter
- Isomart gasket
- Nozzle
- Flange with insulating gasket
- Burner nameplate
- Warranty
- Instruction handbook for installation, use and maintenance



OPTIONAL

- Power modulating kit for temperatures;
- Power modulating kit for pressures;
- Temperature probe 0°-400°C (PT 100 ohm at 0°C);
- Temperature probe 0°-1200°C (K probe);
- Pressure probe 0-3 bar, 0-6 bar, 0-16 bar, 0-20 bar, 0-30 bar;
- Noise protection

The illustrations and data here shown are indicative. F.B.R. Bruciatori S.r.l. reserves the right to bring, without any obligation of warning, any changes that would be appropriate to the continuing development of their products.



F.B.R. Bruciatori S.r.l.

Via V. Veneto, 152 _ 37050 Angiari (VR) _ Italy
Tel. +39 0442 97000 _ Fax + 39 0442 97299
www. fbr.it _ email: fbr@fbr.it

Представительство в Украине:

ООО "ИТАЛГАЗ"

07400, г. Бровары, ул. Ярослава Мудрого, 90, оф.39
тел: (04594) 7-26-62/63 т/ф: (04594) 7-26-66
www.italgaz.com.ua e-mail: office@italgaz.com.ua